

Silicon Planar Zener Diodes

Features

- Total power dissipation: Max. 1 W.
- Wide zener reverse voltage range 3.3V to 330V.
- Small plastic package suitable for surface mounted design.

PINNING

PIN	DESCRIPTION
1	Cathode
2	Anode

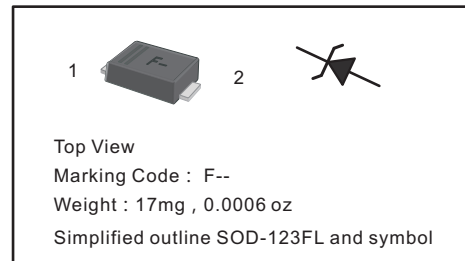

Absolute Maximum Ratings And Characteristics (Ta = 25 °C)

Parameter	Symbol	Value	Unit
Power Dissipation at $T_L=75^\circ\text{C}$	P_D	1	W
Forward Voltage at $I_F = 200 \text{ mA}$	V_F	1.2	V
Typical thermal resistance junction to ambient ⁽¹⁾	$R_{\theta JA}$	55	$^\circ\text{C/W}$
Operating and Storage Temperature Range	T_j, T_{stg}	-55 ~ +150	$^\circ\text{C}$

(1) Thermal resistance from junction to ambient at P.C.B. mounted with 0.2 X 0.2" (5 X 5 mm) copper areas pads.

Fig.1 Maximum Continuous Power Derating

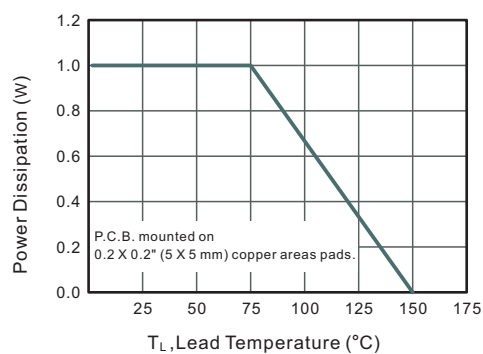
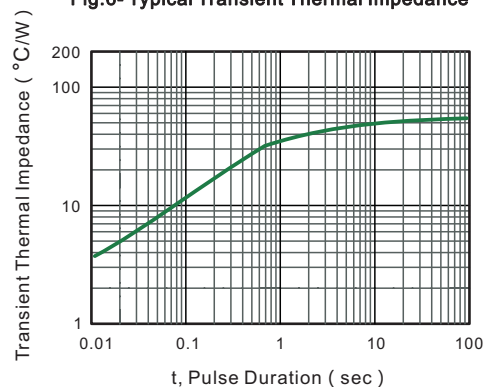

Fig.6- Typical Transient Thermal Impedance



Characteristics at Ta = 25°C

Type	Marking	Zener Voltage Range ⁽¹⁾			I _{ZT}	Dynamic Impedance	Reverse Current		Admissible Zener Current
		V _{ZT} (at I _{ZT})					Z _{ZT} (at I _{ZT})	I _R	
		Min (V)	Nom (V)	Max (V)	(mA)	Max (Ω)	Max (μA)	(V)	I _{ZM} (mA)
MM1W3V3	FHD	3.10	3.3	3.50	75	10	100	1	285
MM1W3V6	FHE	3.40	3.6	3.80	69	10	100	1	263
MM1W3V9	FHF	3.70	3.9	4.10	64	9.0	50	1	243
MM1W4V3	FHG	4.06	4.3	4.56	58	9.0	25	1	219
MM1W4V7	FHJ	4.50	4.7	4.93	53	8.0	10	1	203
MM1W5V1	FHK	4.84	5.1	5.36	49	7.0	10	1	186
MM1W5V6	FHL	5.32	5.6	5.92	45	5.0	10	2	170
MM1W6V2	FHN	5.86	6.2	6.51	41	2.0	10	3	154
MM1W6V8	FHO	6.46	6.8	7.18	37	3.5	10	4	140
MM1W7V5	FHQ	7.12	7.5	7.88	34	4.0	10	5	127
MM1W8V2	FHR	7.79	8.2	8.67	31	4.5	10	6	116
MM1W9V1	FHT	8.60	9.1	9.59	28	5.0	10	7	104
MM1W10	FHU	9.50	10	10.5	25	7.0	10	7	95
MM1W11	FHV	10.4	11	11.6	23	8.0	5	8	86
MM1W12	FHW	11.4	12	12.6	21	9.0	5	9	79
MM1W13	FHX	12.4	13	14.1	19	10	5	10	71
MM1W15	FHZ	13.8	15	15.8	17	14	5	11	63
MM1W16	FJA	15.2	16	17.1	16	16	5	12	58
MM1W18	FJF	16.8	18	19.2	14	20	5	13	52
MM1W20	FJG	19.0	20	21.2	13	22	5	15	47
MM1W22	FJK	20.8	22	23.3	12	23	5	17	43
MM1W24	FJL	22.8	24	26.0	11	25	5	18	38
MM1W27	FJN	25.3	27	28.9	9.5	35	5	21	35
MM1W30	FJQ	28.2	30	32.0	8.5	40	5	23	31
MM1W33	FJR	31.3	33	34.9	7.5	45	5	25	28
MM1W36	FJS	34.2	36	37.9	7.0	50	5	27	26
MM1W39	FJT	37.2	39	41.5	6.5	60	5	30	24
MM1W43	FLG	40.9	43	45.6	6.0	70	1	32	22
MM1W47	FLJ	44.9	47	49.8	5.5	80	1	35	20
MM1W51	FLK	48.6	51	54.0	5.0	95	1	38	18
MM1W56	FLL	53.6	56	58.8	4.5	110	1	42	17
MM1W62	FLN	58.9	62	65.6	4.0	125	1	47	15
MM1W68	FLO	64.6	68	71.7	3.7	150	1	52	14
MM1W75	FLQ	71.2	75	78.8	3.3	175	1	56	12
MM1W82	FLR	77.9	82	87.0	3.0	200	1	62	11
MM1W91	FLT	86.0	91	96.0	2.8	250	1	69	10
MM1W100	FLU	95.0	100	105	2.5	350	1	76	9.5
MM1W110	FLV	104	110	116	2.3	450	1	84	8.6
MM1W120	FLW	114	120	127	2.0	550	1	91	7.8
MM1W135	FLX	125	135	142	1.9	700	1	100	7.0
MM1W150	FLZ	140	150	157	1.7	900	1	110	6.3
MM1W165	FPA	155	165	172	1.6	1100	1	120	5.8
MM1W180	FPF	170	180	191	1.4	1200	1	135	5.2
MM1W200	FPG	189	200	211	1.2	1400	1	150	4.7
MM1W220	FPK	209	220	231	1.0	1600	1	165	4.3
MM1W240	FPL	229	240	251	1.0	1800	1	180	3.9
MM1W260	FPM	249	260	271	1.0	2000	1	190	3.7
MM1W280	FPN	269	280	291	1.0	2100	1	205	3.4
MM1W300	FPQ	289	300	315	1.0	2300	1	230	3.1
MM1W330	FLR	313	330	346	1.0	2500	1	250	2.8

(1) V_{ZT} is tested with pulses (20 ms)

PACKAGE OUTLINE

Plastic surface mounted package; 2 leads

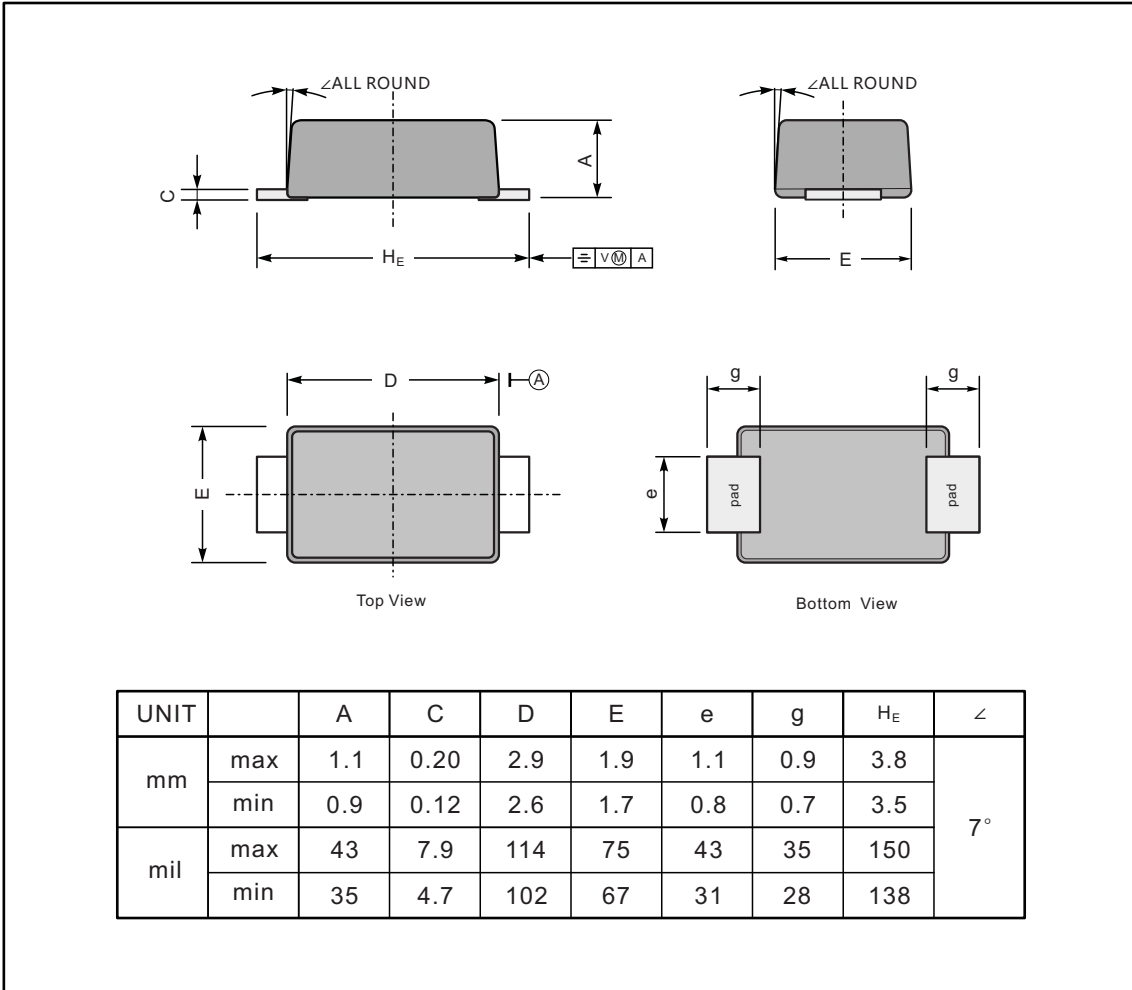

The recommended mounting pad size

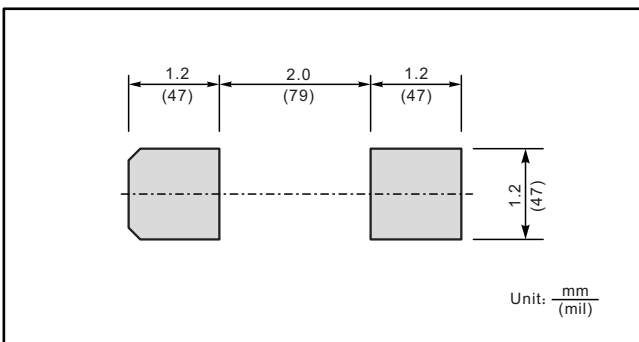

• Recommended condition of flow soldering

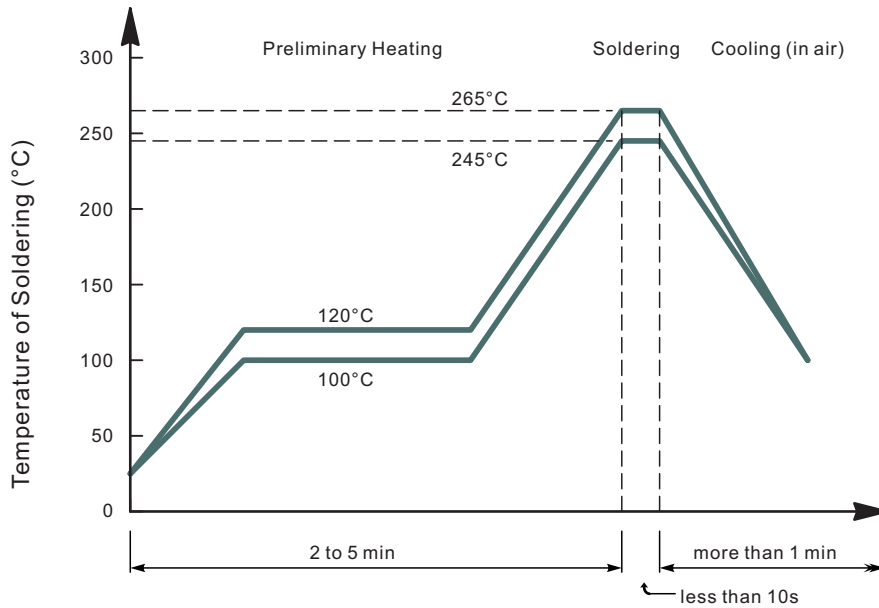

• Recommended condition of reflow soldering

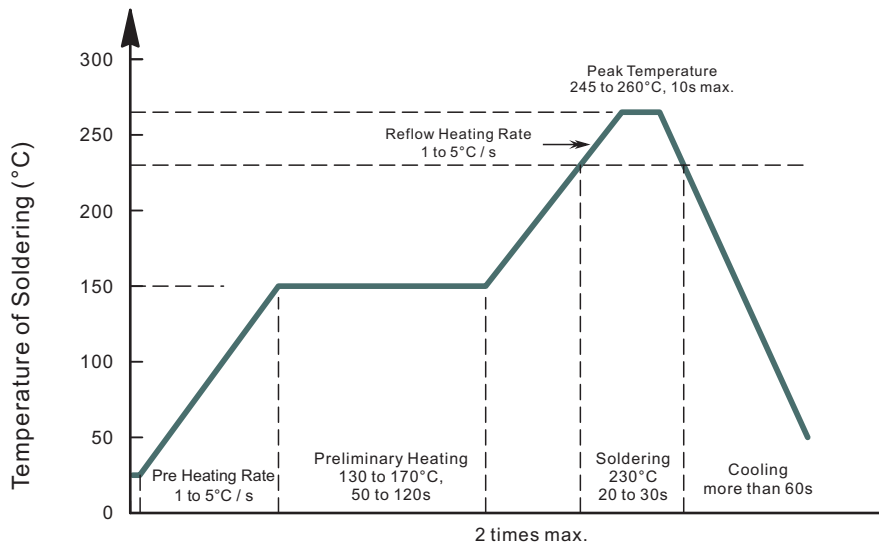

Recommended peak temperature is over 245 °C. If peak temperature is below 245 °C, you may adjust the following parameters; time length of peak temperature (longer), time length of soldering (longer), thickness of solder paste (thicker)

• Condition of hand soldering

Temperature: 365°C
Time: 3s max.
Times: one time

• Remark:

Lead free solder paste (96.5Sn/3.0Ag/0.5Cu)